

# For leading edge technology – trust tradition.

---



## Liquid pumps in accordance with ATEX 95

- Pumping liquids in explosive atmospheres
- Transferring flammable gases and liquids

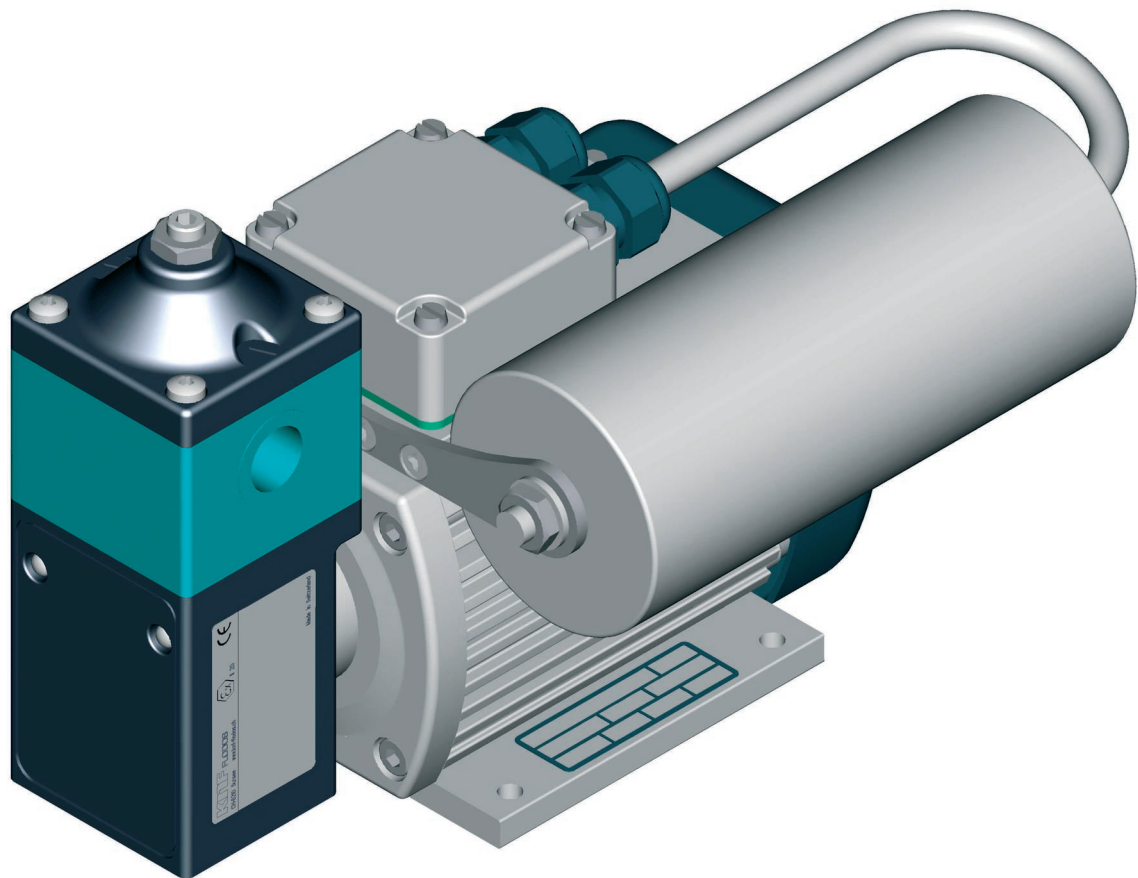

# KNF Neuberger, pumping with ATEX

## Innovative technology worldwide

The KNF Group specializes in the development, manufacture and worldwide marketing of diaphragm pumps and systems for air, gases, vapors and liquids.

ATEX pumps are often required for process engineering and manufacturing in the chemical industry especially in areas which contain explosive gases or when flammable liquids need to be pumped.

We offer two sizes of liquid pumps equipped with our own KNF Ex motor. The NF1.100 and NF1.300 deliver 1.2 l/min and 3.0 l/min respectively and can be equipped with an integrated safety valve (.27) set at 4 bar.

## Know how

The new directive makes the distinction between non-electrical and electrical components (pump head and drive motor) both of which must be taken into consideration when assessing the potential danger of explosion.













**KNF Ex pump head, II 2G Ex c IIB T5 X**  
**KNF Ex motor, 230V/50Hz, II 2G EEx de IIC T4**

There are 12 different pump variations in our product range which comply with the 94/9/EU directive and we would be delighted to offer advice on which is the best for your application.

### Highlights

- Simple, value-for-money construction
- Self-priming, safe dry running
- High resistance to chemicals
- Long service life
- Maintenance free
- Over pressure safety valve

### Selection of standard pumps

Type	Flow rate at atmos. pressure (l/min)	Max. suction head (mWg)	Max. pressure head (mWg)	Material options	
				Head	Valves, diaphragm
NF 1.100_EX	 1.2	 2.5	 40	PP, PVDF	EPDM, FFPM, PTFE
NF 1.100_27EX	 1.2	 2.5	 40	PP, PVDF	EPDM, FFPM, PTFE
NF 1.300_EX	 3.0	 2.5	 40	PP, PVDF	EPDM, FFPM, PTFE
NF 1.300_27EX	 3.0	 2.5	 40	PP, PVDF	EPDM, FFPM, PTFE

Complete specifications and drawings are available for these and other KNF pumps on our website.

**KNF Neuberger, Inc.**  
 2 Black Forest Road • Trenton, NJ 08691  
 www.knfprocess.com • 609-890-8600

