

NFB 25

DIAPHRAGM LIQUID PUMP

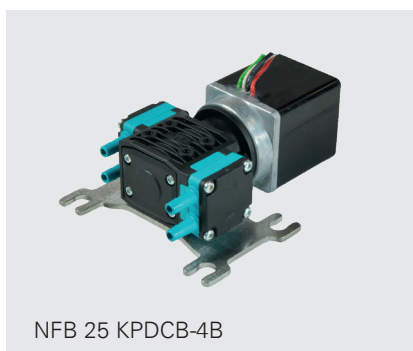

NFB 25 KPDCB-4B

ADVANTAGES

- Self priming and excellent for pressure
- Extreme chemical resistance
- Dry running, durable and maintenance free

POSSIBLE AREAS OF USE

- Analysers
- Laboratory
- Cleaning industry
- Printing

Please visit our website
www.knf.com
 to get more information.

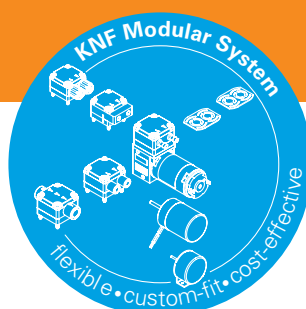

PERFORMANCE DATA

Series model	NFB 25 DCB-B		NFB 25 DCB-4B
Material options	KP	KT	TT
Pump head	PP	PP	PVDF
Diaphragm	EPDM	PTFE	PTFE
Valves	EPDM	FFKM	FFKM
Resonating Diaphragm	EPDM	FFKM	FFKM
Flow rate at atm. pressure (l/min)	2 x 0.3		2 x 0.25
Suction height (mWg)	3		
Pressure head (mWg)	10		
Permissible ambient air (°C)	+5 to +40		
Permissible liquid temperature (°C)	+5 to +80		
Weight (g)	210		
IP protection factor	50		

ELECTRICAL DATA

Operating voltage (V)	12/24	10-26.4
Power consumption (W)	6.5	5.4
I load max (A)	0.54/0.27	0.54-0.22

NFB 25 DCB-B

PERFORMANCE DATA

Series model	Flow rate at atm. pressure (l/min)	Max. suction height (mWg)	Max. pressure head (mWg)
NFB 25 DCB-B	2 x 0.3	3	10

NFB 25 DCB-B

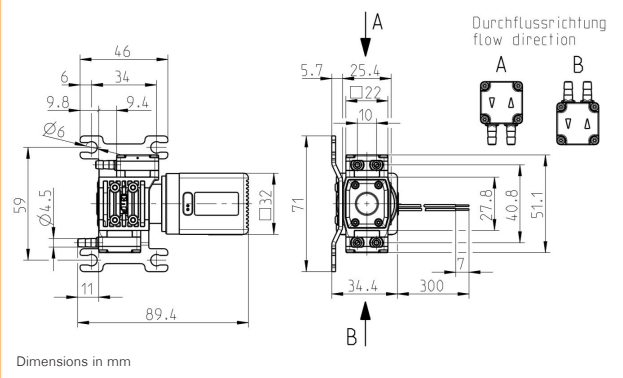

NFB 25 DCB-4B

PERFORMANCE DATA

Series model	Flow rate at atm. pressure (l/min)	Max. suction height (mWg)	Max. pressure head (mWg)
NFB 25 DCB-4B	2 x 0.25	3	10

NFB 25 DCB-4B

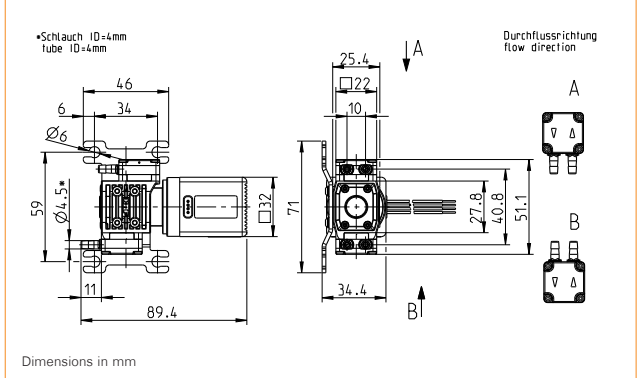

NFB 25 DCB-B FLOW CURVE (PER HEAD)

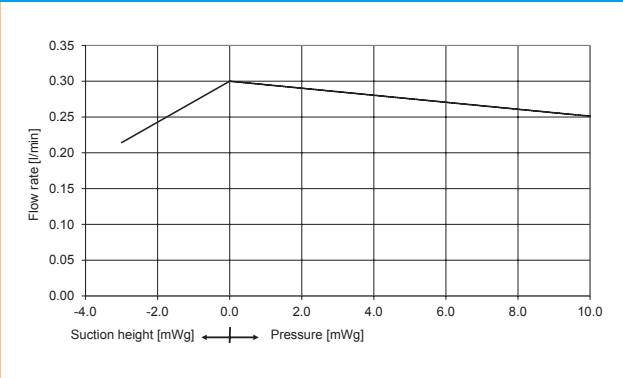

NFB 25 DCB-4B FLOW CURVE (PER HEAD)

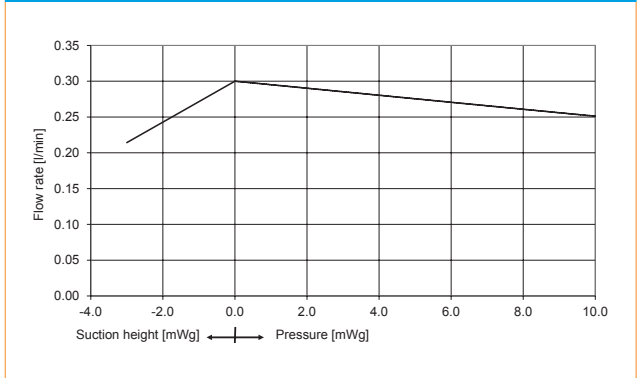

ELECTRIC SPECIFICATION

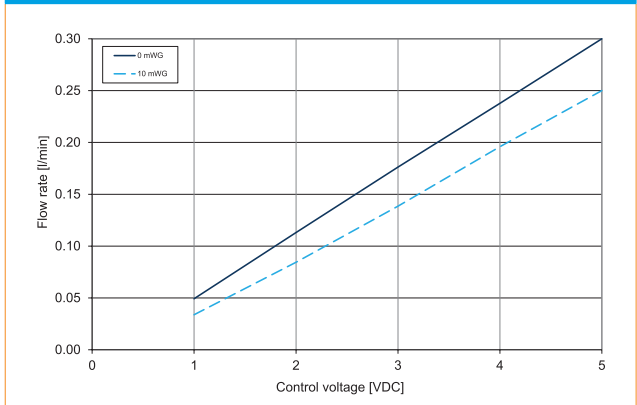

Wires	AWG 24
Wire assignment	red = +VS black = -VS/GND

NFB 25 DCB-4B CONTROL CURVE (PER HEAD)





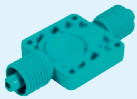

ELECTRIC SPECIFICATION

Wires	AWG 24
Wire assignment	red = +VS black = -VS/GND white = Vctrl-input green = FG-output
Input signal	0-5V

OPTIONS			
Description	Illustration	Part No.	Details
Motors with special voltages or frequencies			
Electrical connectors			Specific customers requirements such as special connections (Molex, AMP, etc.)
Different hydraulic connection types			
Other head materials			

DIGITAL CUSTOMIZATION

Thanks to digital technology, this pump can be quickly adapted to the customer's system. This is done by parametrizing the firmware of the motor at KNF.

ACCESSORIES			
Description	Illustration	Part No.	Details
Fastening elements			
Diaphragm pressure control valve			The pressure control valve can be used for a more accurate control of flow against a fluctuating back pressure, metering into a vacuum and from a pressurised system.
Pulsation damper			This very versatile pulsation damper reduces the vibration in hoses and pipes and it helps to remove pulsation which is preventing the system from functioning correctly.
Filter			KNF filters protect both pumps and other upstream instrumentation and hydraulic circuits against particulate, crystals and fibres which can improve optimum operation.

The performance values for the series models shown on this data sheet were determined under test conditions. The actual performance values may differ and depend in particular on the usage conditions and therefore on the specific application, on the parameters of the components involved in the user's system and on any technical modifications carried out which deviate from the standard configuration or the as delivered condition.

If individual designs have been created for specific customers on the basis of series models, other technical performance data may apply. Before operation begins, the relevant operating instructions and/or assembly or installation instructions should be read and the safety information contained in these instructions should be noted. KNF reserves the right to make changes to the product and the associated documentation without prior notice to the customer.



www.knf.com